

<b>715212</b>	ÖBB	BR 52	=		N
---------------	-----	-------	---	--	---

<b>715292</b>			=	🔊	N
---------------	--	--	---	---	---

Pos. Nr. Pos.no.	Beschreibung Description	Art.-Nr. Art.no.	Preisgruppe Price bracket
1	LOKGEHÄUSE KPL. Betr. Nr. 52.3440 Loco chassis complete no. 52.3440	10715212	029
2	UMLAUFBLECH Running board	11715212	025
3	LICHTLEITER Light conductor	13715201	006
4	PFEIFE Whistle	00197605	004
5	LOKFAHRGESTELL KPL. Loco chassis complete	30715212	040
6	LOKFAHRGESTELL MIT RÄDERN Loco chassis with wheels	31715212	032
7	STEUERUNG KPL. MIT KUPPELSTANGEN Reversing gear compl. with coupling rod	32715201	017
8	ABDECKPLATTE UNTEN Cover plate bottom	00337186	006
9	VORLAUFGESTELL KPL. Carrying wheel	37715207	016
10	KUPPELLASCHE LOK-TENDER Coupling latch loco tender	38802100	004
11	ZYLINDERKASTEN KPL. BR 52 Cylinder box complete BR 52	48715201	013
12	KUPPELRAD Coupled wheel	00517062	007
13	TREIBRAD LINKS Driving wheel left	00517072	008
14	TREIBRAD RECHTS Driving wheel right	00517073	008
15	KUPPELRAD Cupled wheel	00517074	008
16	ACHSE Axle	00527007	001
17	VORLAUFRADSATZ KPL. Carrying wheelset complete	00537030	011
18	LEITERPLATTE KPL. PCB complete	65714100	022
19	LEITERPLATTE KPL. PCB complete	65714200	022
20	STECKER FÜR SCHNITTSTELLE 6-POL Jumper 6-pin	66401600	013
21	LINSENSCHRAUBE M1,6x2-4,8 H Button screw M1,6x2-4,8 H	00704902	002
22	LINSENSCH. M1,6x4 M. KREUZ-SCHLITZ Button screw M1,6x4 with cross-slot	00704904	002
23	BLECHSCHRAUBE MIT KREUZSCHLITZ Tapping screw	00713309	001
24	BOLZEN FÜR KUPPELSTANGE Bolt for coupling rod	00730562	002
25	BOLZEN FÜR KUPPELSTANGE Bolt for coupling rod	00730570	001
26	ZUGFEDER SCHWARZ Draw spring black	76710800	001
27	FEDERBÜGEL FÜR ZUGFEDER Spring clip for draw spring	76711000	001
<b>Sound</b>			
28	LOKGEHÄUSE KPL. Betr. Nr. 52.3440 Loco chassis complete no. 52.3440	10715292	029
29	LOKFAHRGESTELL KPL. Loco chassis complete	30715292	040
30	LAUTSPRECHER Loudspeaker	68702500	016
31	LAUTSPRECHERAUFNAHME Loudspeaker reception	68701400	016
32	SOUND-DECODER Sound decoder	68715277	039
33	BUNDBOLZEN Flanged bolt	73059800	003

Änderungen in Konstruktion und Ausführung vorbehalten  
We reserve the right to change the construction and specification

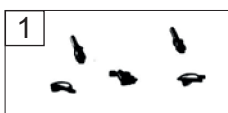
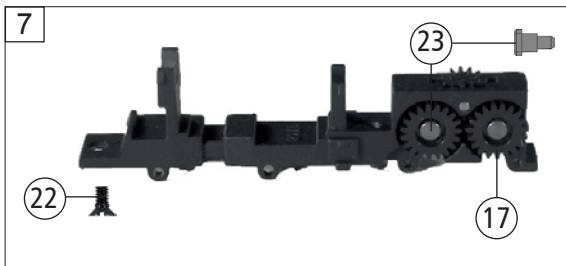
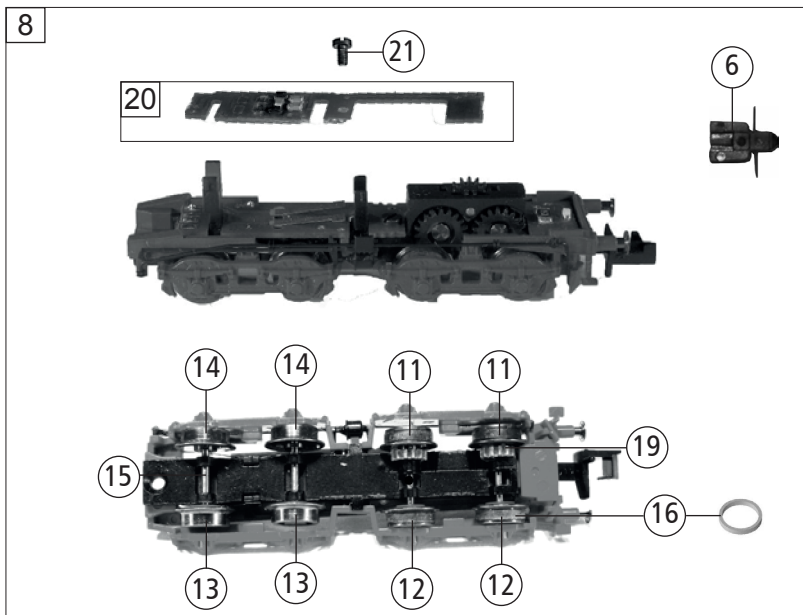
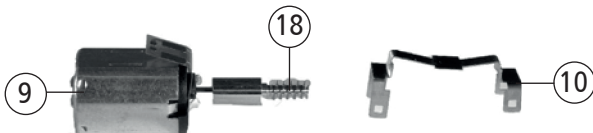
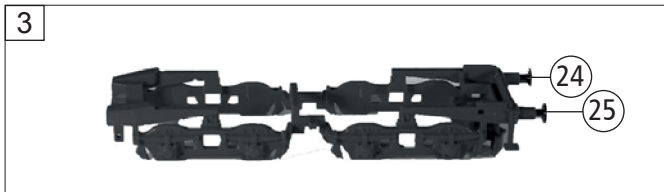
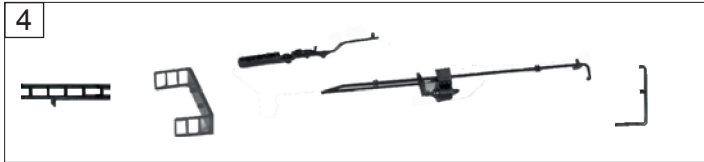
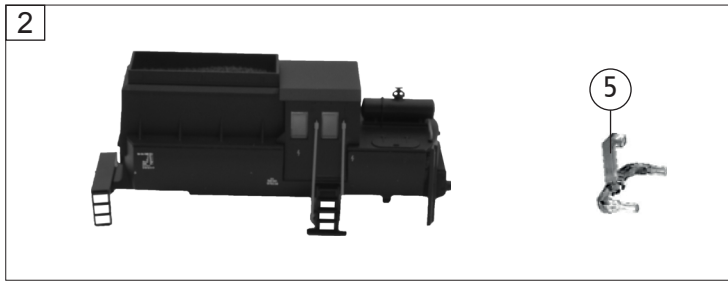

Pos. Nr. Pos.no.	Beschreibung Description	Art.-Nr. Art.no.	Preisgruppe Price bracket
715212	ÖBB BR 52	=	N
715292		=	N
1	ZUGHAKEN-BREMSKU.-KOLBENST. Coupl.hook, brake coupl.piston rod	19715201	012
2	TENDERGEHAEUSE KPL. Betr.Nr.52.3440 Tender body complete no. 52.3440	20715212	027
3	TENDERRAHMEN KPL. Tender framework complete	21715212	023
4	LEITER-TREPPE-HANDLAUF-ROHRLEIT. Ladder-treadle-handrail-pipe	22715212	011
5	LICHTLEITER FÜR TENDER Light conductor for tender	23715201	006
6	ADAPTER Adaptor	38702400	007
7	TENDERFAHRGESTELL MIT ZAHNRÄDER Tender chassis with gears	41715201	027
8	TENDERFAHRGESTELL KPL. O. MOTOR Tender chassis complete w/o motor	40715212	033
9	MOTOR Motor	50715201	030
10	MOTORHALTEBÜGEL Motor retainer clip	50791400	002
11	TENDERRAD M.N. Tender wheel with traction tyre	51713500	007
12	TENDERRAD M.N. Tender wheel with traction tyre	51713600	007
13	LOKRAD O.N. Loco wheel w/o traction tyre	51713700	004
14	LOKRAD O.Z. O.N. Loco wheel w/o gearwh.w/o tract. tyre	51713800	003
15	ACHSE Axle	52701200	001
16	HAFTREIFEN Traction tyre	00547001	001
17	ZAHNRAD Gear wheel	56718100	003
18	SCHNECKE (MESSING) Worm gear	56762200	009
19	RITZEL Gear wheel	56762000	001
20	LEITERPLATTE KPL. (TENDER) PCB complete (tender)	65714000	018
21	SCHRAUBE M 1,4 X 3 Screw M 1,4 X 3	00700203	001
22	SCHRAUBE Screw	00702304	001
23	BUNDBOLZEN Flanged bolt	00730578	003
24	STECKPUFFER (GEWÖLBT) Plug-in buffer (curved)	00757011	002
25	STECKPUFFER (FLACH) Plug-in buffer (flat)	00757012	002
26	STANDARD-STECKKUPPLUNG Standard clip in coupling	9525	---
27	PROFI-STECKKUPPLUNG Pro clip in coupling	9545	---
28	PROFI KUPPLUNG Pro coupling	9541	---
29	STANDARD KUPPLUNG Standard coupling	9521	---

Ersatzteile erhalten Sie direkt unter [www.fleischmann.de](http://www.fleischmann.de), bei Ihrem Fachhändler oder Ihrer Landesvertretung.  
Spare parts can be ordered directly at [www.fleischmann.de](http://www.fleischmann.de) and from your local dealer or country representative.